

MDE018..

Video delle istruzioni:
Product Instructions:

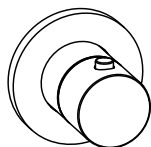

<https://www.paffoni.it/info/modular-box?q=mde018>



INSTALLAZIONE VERTICALE
VERTICAL INSTALLATION

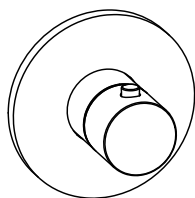
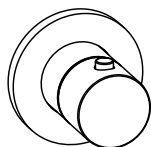

INSTALLAZIONE ORIZZONTALE
HORIZONTAL INSTALLATION

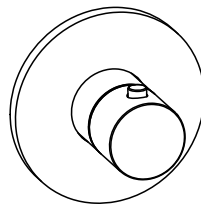
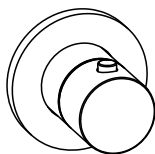
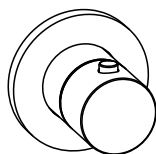

INSTALLAZIONE VERTICALE VERTICAL INSTALLATION

INSTALLAZIONE ORIZZONTALE HORIZONTAL INSTALLATION

1

Montaggio
Assembly



EN1717



$65 \pm 5^\circ\text{C}$



$15 \pm 5^\circ\text{C}$



MIN - MAX



OK

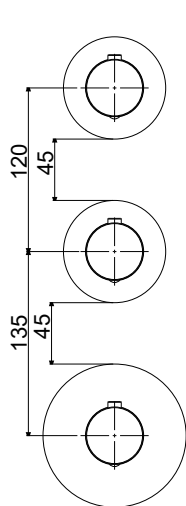

INSTALLAZIONE VERTICALE
VERTICAL INSTALLATION

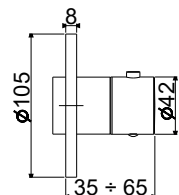
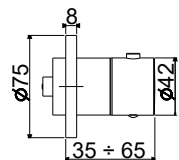
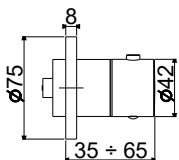

INSTALLAZIONE ORIZZONTALE
HORIZONTAL INSTALLATION

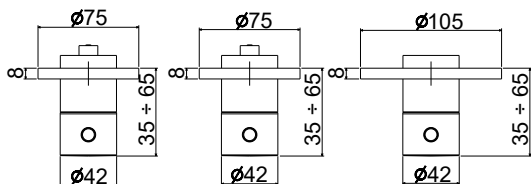
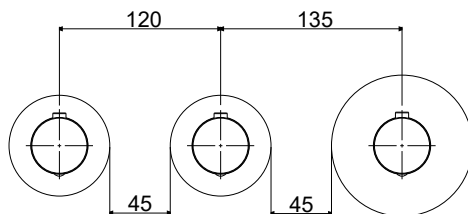

1

INSTALLAZIONE VERTICALE VERTICAL INSTALLATION

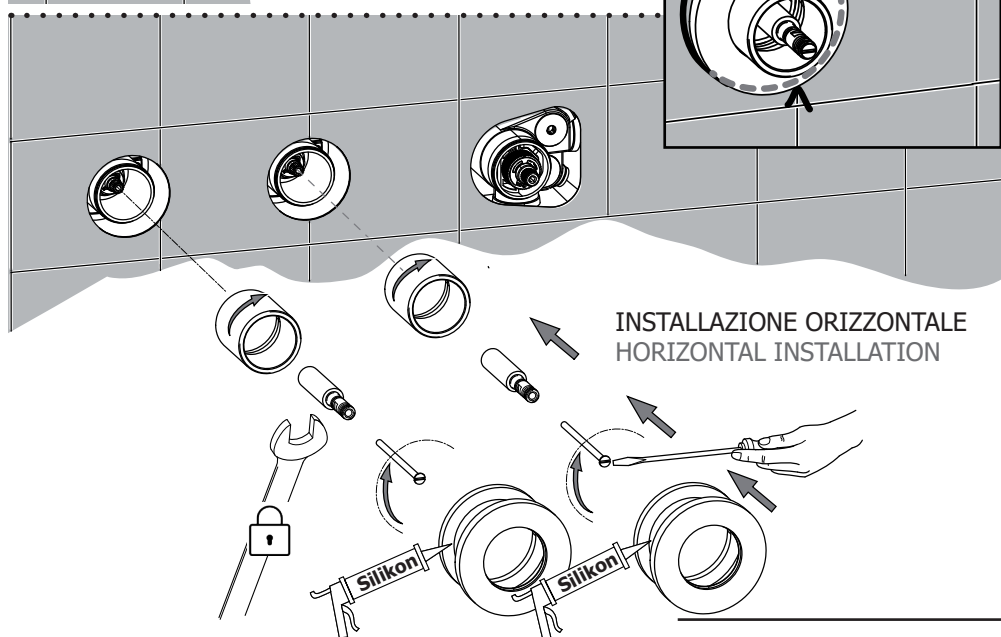
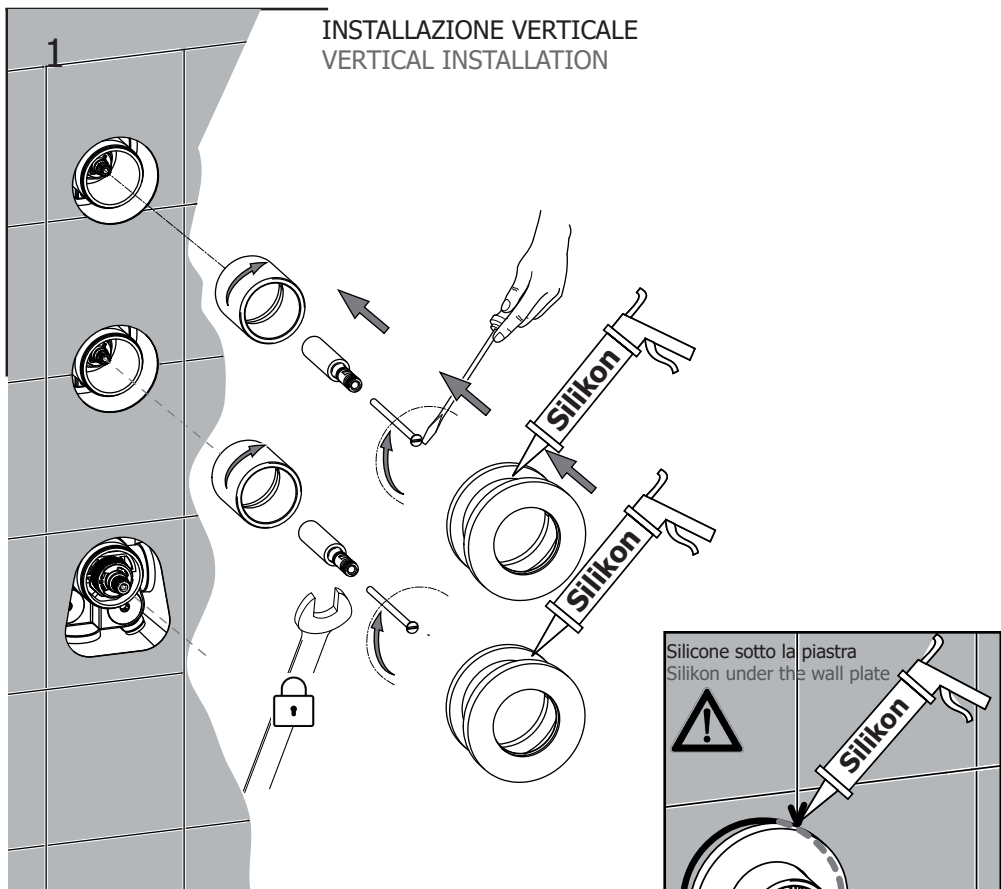

2

INSTALLAZIONE VERTICALE
VERTICAL INSTALLATION

NO

OK

38°

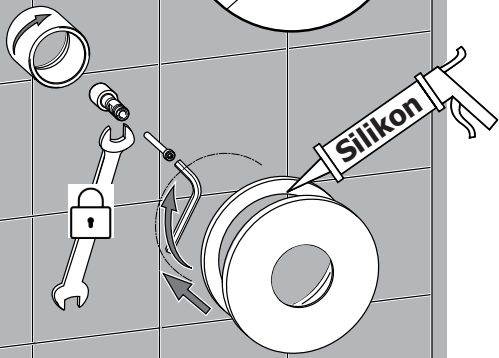
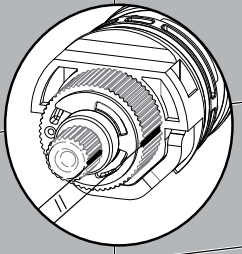
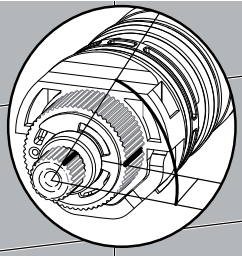
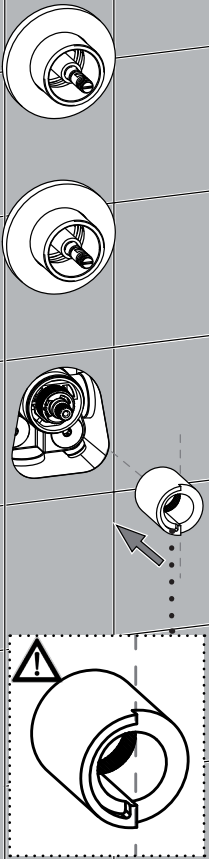

INSTALLAZIONE ORIZZONTALE
HORIZONTAL INSTALLATION

NO **OK**

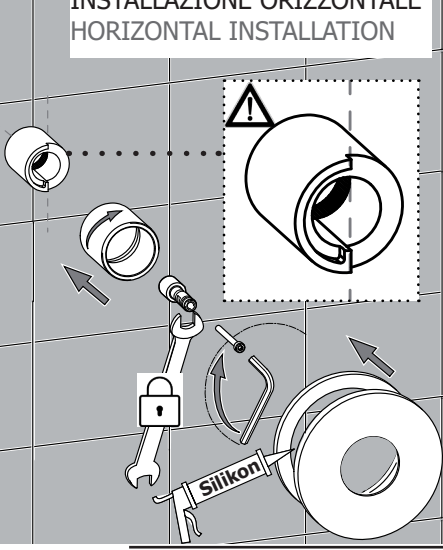
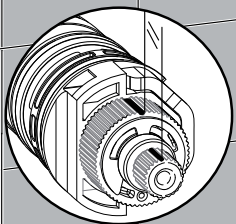
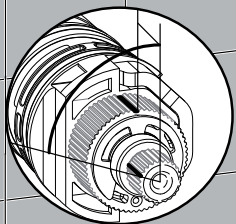
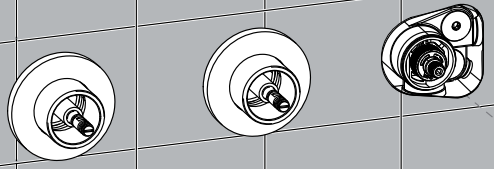

3 Maniglie vitoni
Ceramic disk valve Handle

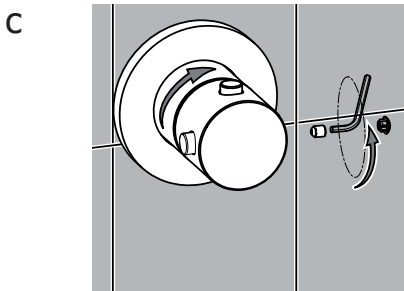
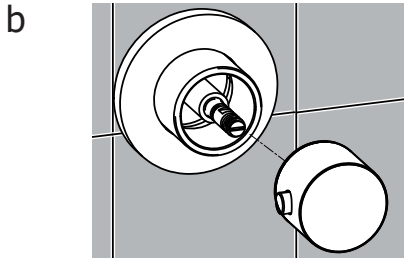
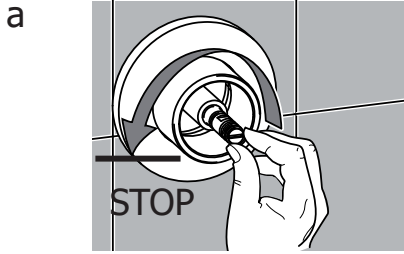

INSTALLAZIONE VERTICALE
VERTICAL INSTALLATION

INSTALLAZIONE ORIZZONTALE
HORIZONTAL INSTALLATION

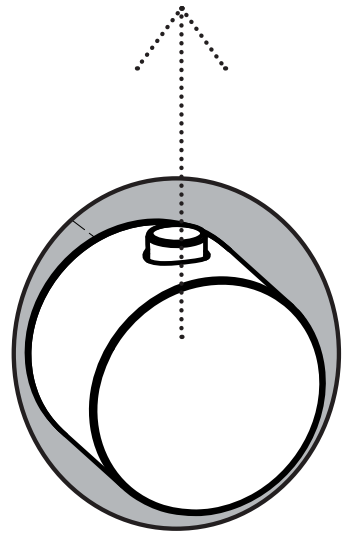

.....
Maniglie termostatica
Thermostatic cartridge Handle

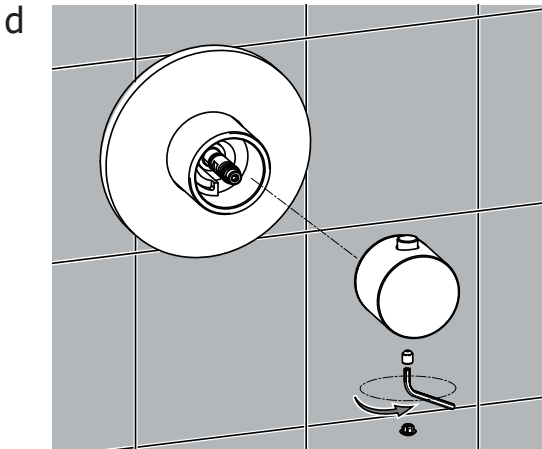

POMOLO RIVOLTO
SEMPRE VERSO L'ALTO
KNOB ALWAYS
UP DIRECTED

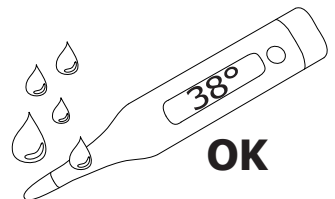

Manutenzione Service

INSTALLAZIONE ORIZZONTALE HORIZONTAL INSTALLATION

INSTALLAZIONE VERTICALE VERTICAL INSTALLATION

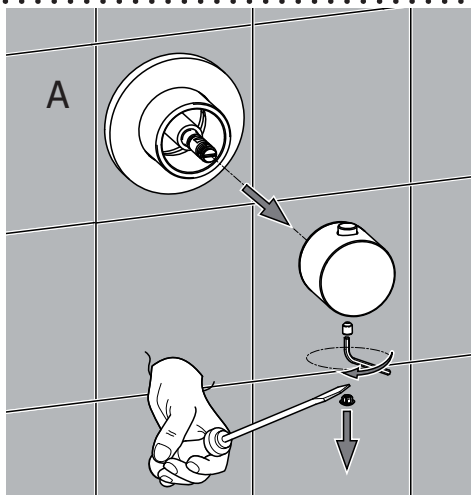
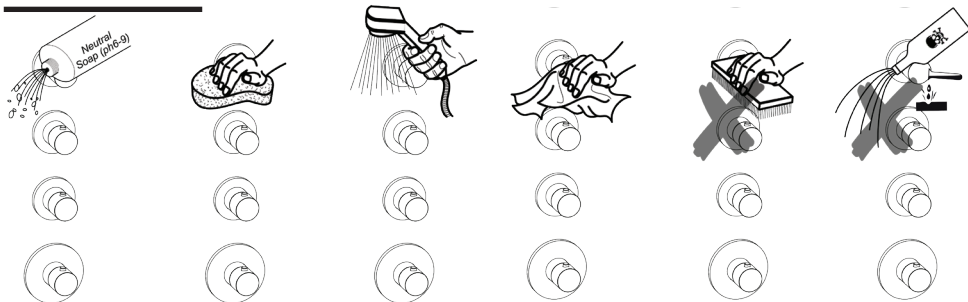

Sostituzione Maniglia How to replace Handle

Per Vitone e
Cartuccia Termostatica
For Ceramic Disk Valve
and Thermostatic
Cartridge

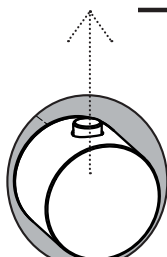

POMOLO RIVOLTO
SEMPRE VERSO L'ALTO
KNOB ALWAYS
UP DIRECTED

INSTALLAZIONE VERTICALE
VERTICAL INSTALLATION

INSTALLAZIONE ORIZZONTALE
HORIZONTAL INSTALLATION

Regolazione Cartuccia Termostatica Setting Thermostatic Cartridge

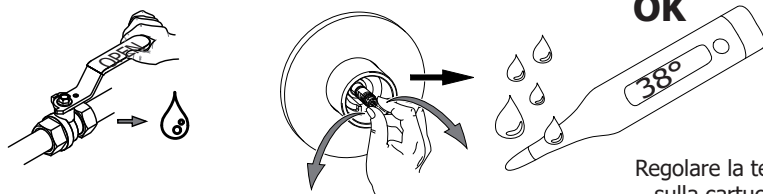

Regolare la temperatura dell'acqua
sulla cartuccia ed eventualmente
riverificarla prima di fissare la maniglia

Setting water temperature on
cartridge and in case recheck it
before assemble the handle

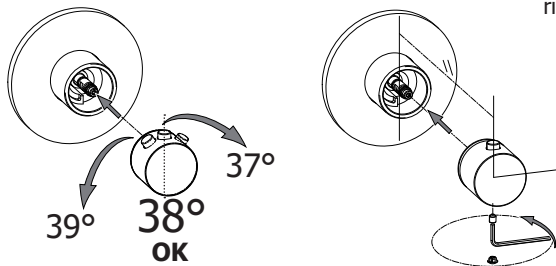

Sostituzione Sede con
Valvolina antiritorno
How to replace Seat with
Check Valve

INSTALLAZIONE VERTICALE
VERTICAL INSTALLATION

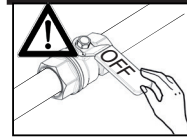
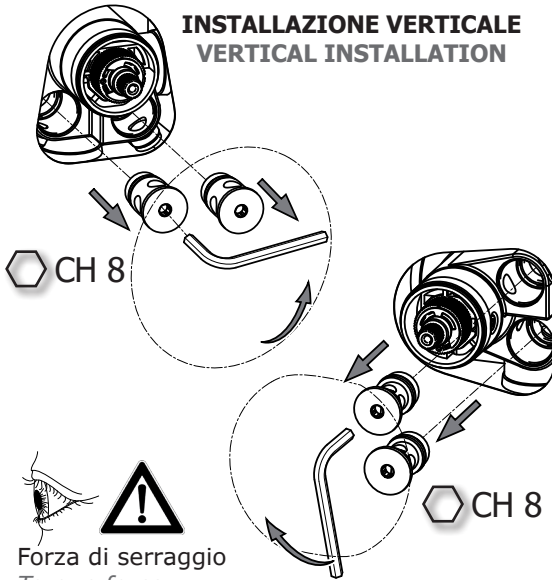

INSTALLAZIONE ORIZZONTALE
HORIZONTAL INSTALLATION



Forza di serraggio
Torque force
10 N/m

Sostituzione Vitoni ceramici
How to replace Ceramic Disk Valve

INSTALLAZIONE VERTICALE
VERTICAL INSTALLATION

INSTALLAZIONE ORIZZONTALE
HORIZONTAL INSTALLATION

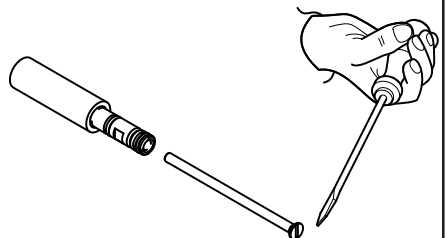
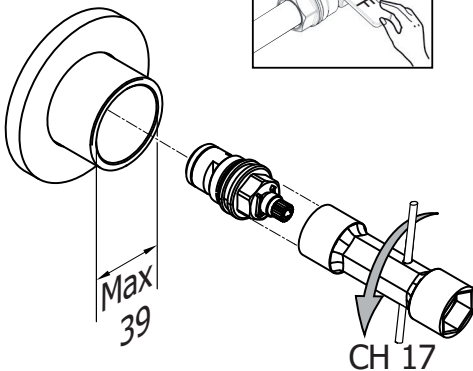
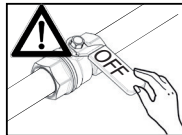
B



Sostituzione Cartuccia Termostatica
How to replace Thermostatic Cartridge

INSTALLAZIONE VERTICALE
VERTICAL INSTALLATION

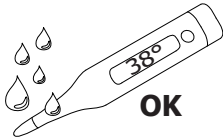
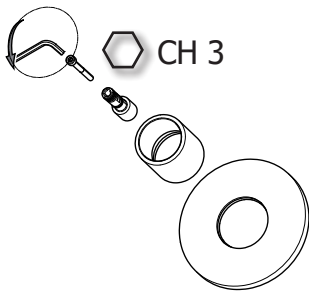

Mantenere sempre 90° tra lo scalino sulla CAM e le linee di riferimento sulla cartuccia

Always keep 90 ° between the step on the CAM and ref. lines on the cartridge

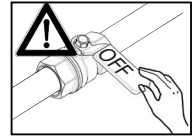
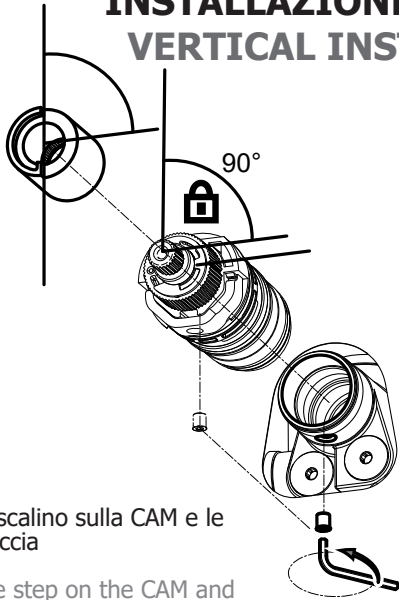

Leggera forza di serraggio
Light torque force

CH 2,5

INSTALLAZIONE ORIZZONTALE
HORIZONTAL INSTALLATION

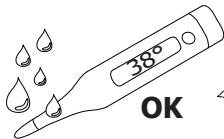
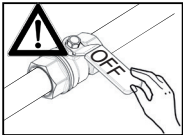

CH 3

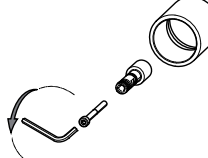

Mantenere sempre paralleli tra loro in verticale lo scalino sulla CAM e le linee di riferimento sulla cartuccia

Always keep the step on the CAM and ref. lines on the cartridge parallel to each other in vertical

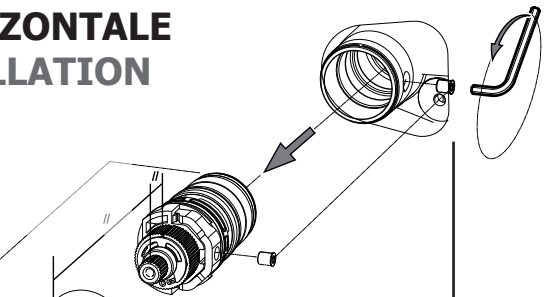

CH 2,5
Leggera forza di serraggio
Light torque force